



China:

GUANGZHOU PRINT AREA TECHNOLOGY CO.,LTD

Add: Room 128, Building G, NO.55 Huadi South Avenue, Liwan District, Guangzhou,China
Tel: +86 20 81408128 Skype: yy.ink Email: yyink@yyink.com Web: www.enyyink.com

FOSHAN YINYA TECHNOLOGY CO., LTD

Add: H01, Building H, Guangping International Trade And Industrial Center, Nanhai District, Foshan
Tel: +86-757-86716019 Skype: yy.ink Email: AVA@yyink.com Web: www.enyyink.com

Myanmar: PRINT AREA TECHNOLOGY COMPANY LIMITED

Add: NO.297(upper Block), 40 Street, kyauktada, Township, yangon, Myanmar
Tel: 09 261480719 09 261480718 Email: ink@yyink.com :PrintArea
Web:www.enyyink.com :09 261 480 718

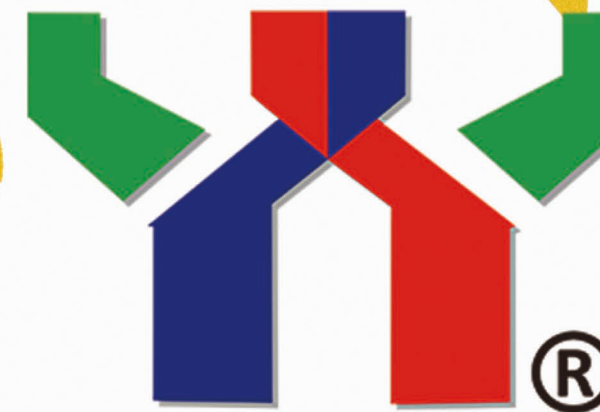

Print Area

With dream and passion

Print Area create a colorful world for you!



Print Area

Pantone Spot Color Centre of South China



Founded in 2004, Guangzhou Print Area Techology Co.,Ltd has our own professional ink R&D Department. We have developed high-quality eco-friendly soy offset printing ink, including the anti-skinning high gloss offset printing ink, all kinds of security inks etc.

Moreover, in order to meet customers' requirements, we set up the spot color center to custom made all the pantone colors.

With the development of trade, we had set up branches and CTP center in Myanmar. Sevre and lead the local printing industry.

Make the purchasing of printing enterprises in the world easier, better price, better quality!
 Become the first partner of printing customers purchasing in China!
 Integrity, cooperation and win-win innovation

According to customers's requirements, we could customize different special inks, such us soy ink, high temperature resistance ink, UV ink for paper/PET/Cardboard/Tube printing, Optical Variable ink, thermochromic ink, invisible ink, watermark ink, magnetic ink, solar discoloration ink, infrared excitation ink, infrared absorb ink, mirror ink, scratch off ink, glow in the dark ink, perfume ink, electric conductive ink, dielectric Ink etc.

Thanks to the clients from 169 countries recognition, we will be better and stronger in the future.



Catalogue

Ceres Offset Ink-----	03-06
YY Pantone Spot Color-----	07
YY Auxiliary Offset Ink-----	08
YY Offset Printing Ink-----	09
YY UV Ink-----	10
YY UV Material-----	11
Special Ink-----	12-16
Printing Blanket-----	17
Hot Melt Adhseive-----	18
Printing Material-----	19-20
Printing Chemical-----	21
Printing Spare Part-----	22
Printing Spare Part-----	23-29
Air Filter-----	30
Double Wire - 0-----	31
YY Mchine-----	32



Integrity

Cooperation

Win-win situation

YT-02 Ink

High Color Density
and Quick Dry



Water and Rub Resistance



High Gloss



Environmental Protection

YT-03 Ink



High Gloss



Water and
Rub Resistance



High Color Density
and Quick Dry



Environmental
Protection

YT-09 Ink

High gloss



**High Color Density
and Quick Dry**

**Water and Rub
Resistance**



YT-06 Ink

High color concentration

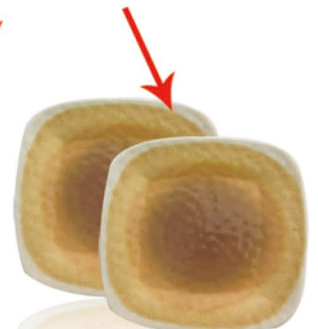
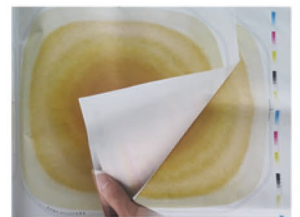

Not easy to change color



High temperature resistance

PANTONE SPOT COLOR SERIES

YT-904 Reflex Blue

YT-905 Warm Red

YT-906 Orange 021

YT-907 Green

YT-908 Ultramarine Blue

YT-910 Rhodamine Red

YT-911 Rubine Red

YT-912 Purple

YT-913 Violet

YT-914 Red 032

YT-915 Blue 072

YT-916 Process Blue

YT-917 Special Black

YT-919 White

YT-925 Reflex Blue * (This ink will not change colour)

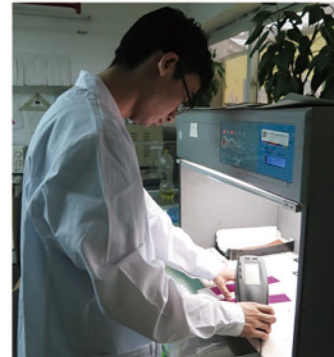

AUXILIARY OFFSET INK

DESCRIPTION	FEATURES	PACKAGING
YT-300 * Primer Coating for Paper	Remedy the powder dropping, wrinkle and other quality problem of the paper. Improve printing quality.	2.5KG/Can, 6 Cans/Carton
YT-500 * Matt OP Varnish	Excellent matt effect, Fast drying and high transparency.	2.5KG/Can, 6 Cans/Carton
YT-660 * Gloss OP Varnish	Higher mirror surface effect and fast drying. High transparency and tenacity and not easy to turn yellow.	2.5KG/Can, 6 Cans/Carton
YT-901 * Clear Medium	High transparency and gloss. Not easy to yellow.	2.5KG/Can, 6 Cans/Carton
YT-902 * Jelly Compound	Reduce the viscosity of the ink efficiently. Transparent jelly condition.	2KG/Can, 6 Cans/Carton
YT-903 * Varnish	Reduce the viscosity of the ink efficiently. Promote the glosses and fast drying	3KG/Can
YT-917 * Special Black	High concentration, super black and high gloss. Rich layering, good reappearance dot.	1KG/Can, 12Cans/Carton
YT-919 * White	Super White, outstanding hiding power. Not yellowing after printing.	1.5KG/Can, 12 Cans/Carton

* **Special Recommendation**



YY Offset Printing Ink



YT-901 Transparent Medium
Packing :
2.5kg/can, 6cans/carton



YT-300 Primer Coating
Packing :2.5 kg/can, 6cans/carton



YT-902 Jelly compound (viscosity reducer)
Packing :1kg/can, 12cans/carton
2.5kg/can, 6cans/carton



YT-500 Matt OP Varnish
Packing :
2.5 kg/ can, 6cans/ carton



YT-660 Gloss OP Varnish
High gloss
Packing :2.5kg/can, 6cans/carton



- Pantone 801C
- Pantone 802C
- Pantone 803C
- Pantone 804C
- Pantone 805C
- Pantone 806C
- Pantone 807C

YY Offset Printing Fluorescent Ink



YY-588 UV Varnish (Coated)



YY-609 UV Varnish (Not Coated)

Ceres 100 (UV Drip off varnish)
Ceres 200 (UV Drip off primer)

**The Best
Partner**

- Go directly hot stamping after printing.
- Exquisit line 0.10mm perfect performance.
- Lines interval could be controlled to a minimum 0.10mm.

Low Odor, Good Flexibility

*Reduce the production cost,
Earn more profits*



You design, I print



Ceres UV Ink





Optical Variable Ink

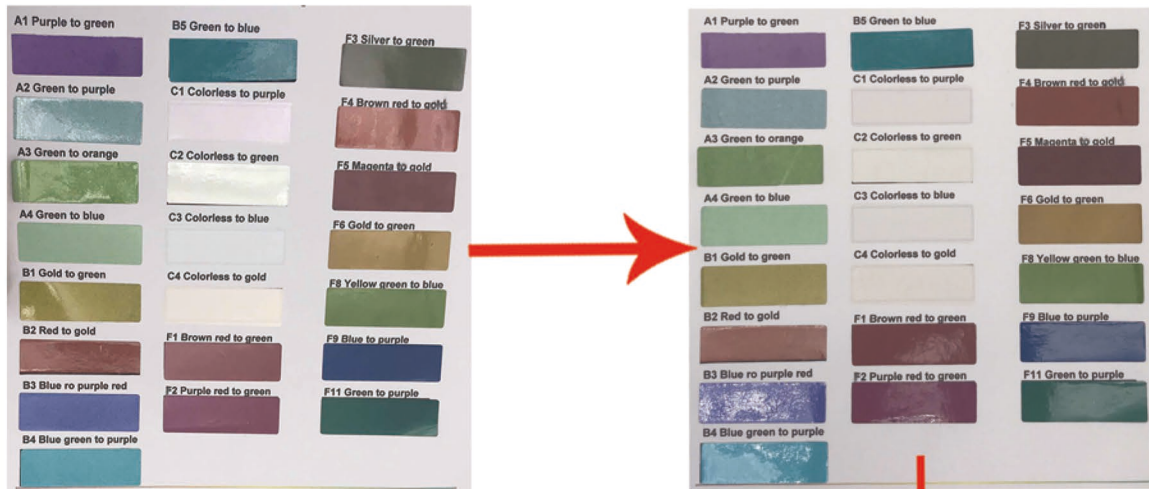

Different angles show different colors

We could produce all kinds of special inks,
such as

UV Fluorescent Invisible Ink,
Optical Variable Ink, Watermark Ink,
Temperature Sensitive Ink,
Solar Discoloration Ink, Mirror Ink,
Infrared Excitation Ink, Magnetic Ink etc.

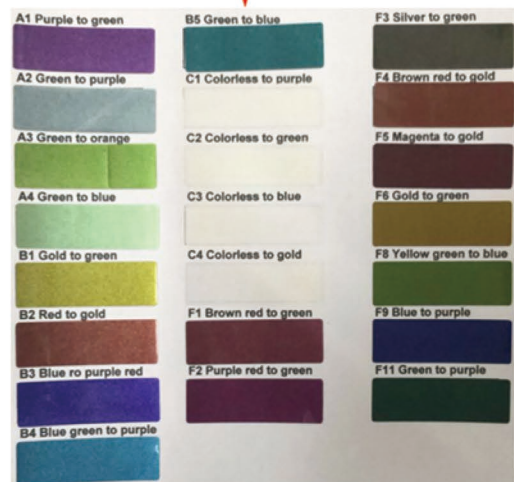

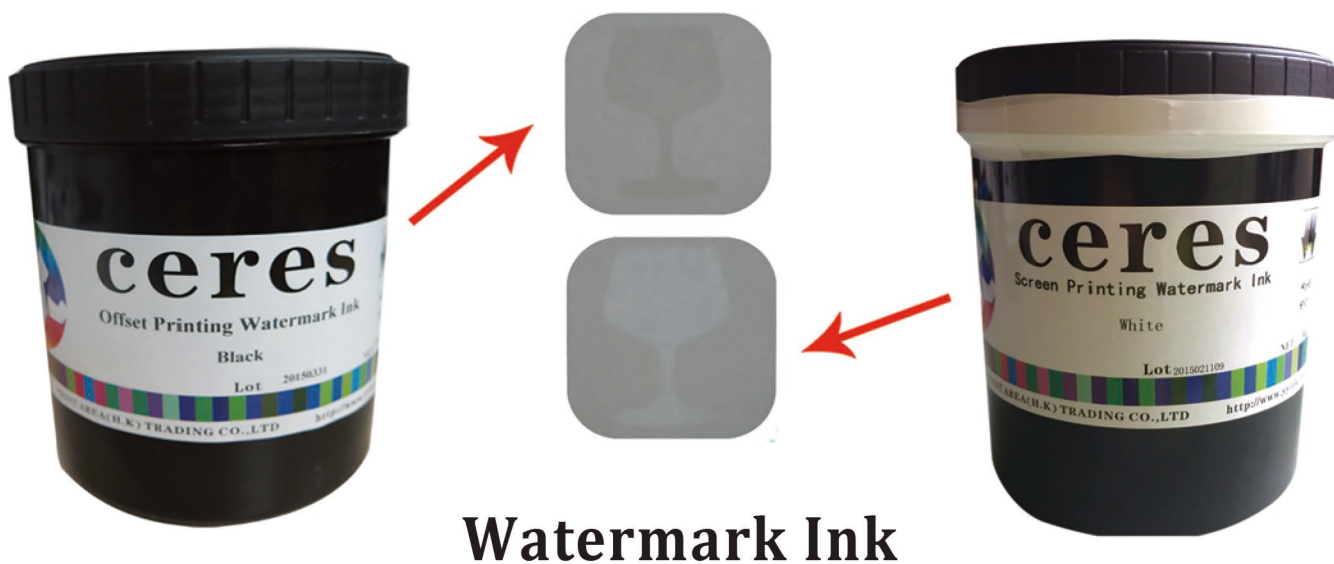

Under the daylight



Under the UV Light

Offset Printing UV Invisible Ink

Under the Day Light

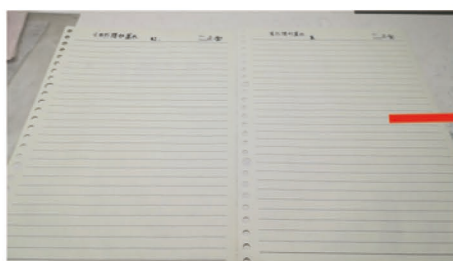

Under the UV Light

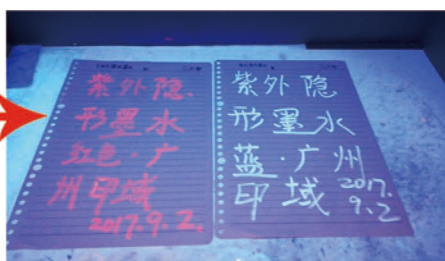

Under the Day Light

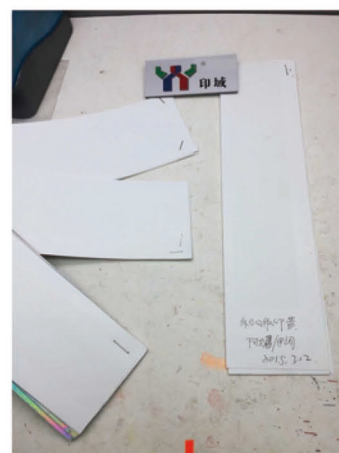

Under the UV Light



Special Ink

- Red
- Yellow
- Blue
- Green

Normal light

IR Light

Infrared Excitation Pen

Infrared Excitation Ink **Infrared Absorb Ink**

Water Sensitive Ink

Water Diffusion Ink

Magnetic Ink

Laser Ink

Scratch Off Ink

Gold Redish
Gold Bluish
Silver

Product: **ceres** Screen Printing Scratch Off Ink, Bluish Gold, Lot 20150321, PRINT AREA (H.K.) TRADING CO., LTD. <http://www.cerestk.com>

Application: A hand scratches a blue card with a scratch-off ink design, revealing a white area with text: 编号: 12345678, 批号: C1234567, 密码: [redacted].

Perfume Ink

- Rose
- Lily
- Lavender
- Jasmine
- Orchid
- Banana
- Onion
- Strawberry
- Cherry
- Lemon
- Orange
- Apple
- Cream
- Coffee
- Peach
- Watermelon

(More flavors for you to choose)

Product: **ceres** Screen Printing Fragrance Ink, Mint, Green Tea, Orange, Cherry.

Screen Printing Photochromic Ink

Temperature Sensitive Ink (15°C 31°C 33°C 50°C 60°C etc.)

Indoor Under the Daylight
Outdoor Under the Sunlight

Product: **ceres** Screen Printing Temperature Sensitive Ink, Black to Colorful, Lot 20150321, PRINT AREA (H.K.) TRADING CO., LTD.

Application: A white t-shirt with a cartoon character is shown under daylight (indoor) and under sunlight (outdoor). The ink changes color from black to purple and blue. Another application shows a water bottle with a butterfly design that changes color when heated.

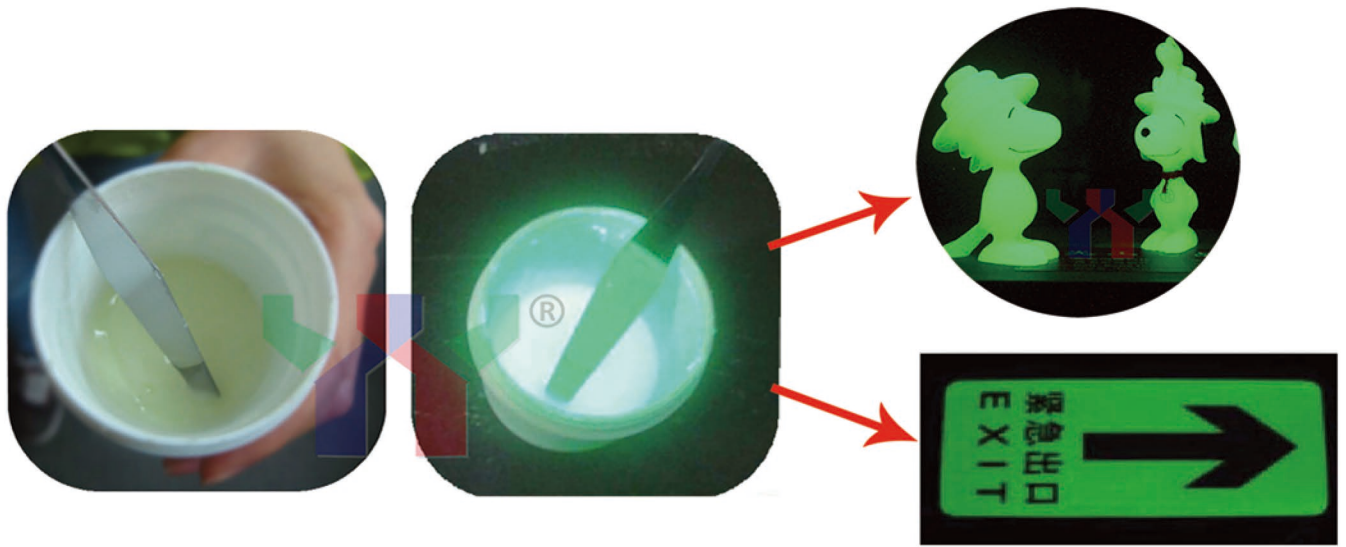

Glow In Dark Ink



Water Sensitive Ink

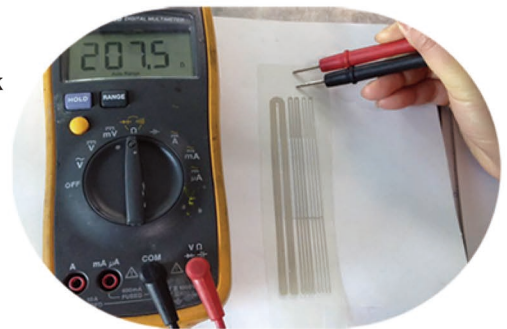

Screen Printing Electrical Conductive Ink



Mirror Ink ● Gold ● Silver

Hot Melt Adhseive



Hot melt adhesive for bookbinding



Printing Material



Cutting Sticks (All the sizes could be customized)
(PE/ PVC /NYLON)

Polar Cutting Sticks (For different sizes)

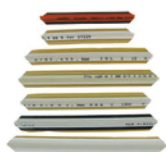
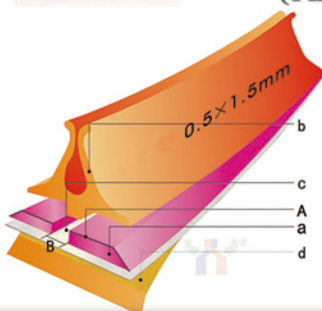

CERES Creasing Matrix

Weight	Thickness	Height					
		23.5	23.4	23.3	23.2	23.1	23
200	0.28 mm	0.3*1.0	0.4*1.0				
250	0.35 mm	0.3*1.2	0.4*1.2	0.5*1.2			
300	0.42 mm	0.3*1.3	0.4*1.3	0.5*1.4			
350	0.50 mm		0.4*1.4	0.5*1.5	0.6*1.5		
400	0.56 mm			0.5*1.6	0.6*1.6		
450	0.63 mm			0.5*1.7	0.6*1.7	0.7*1.7	
500	0.70 mm					0.7*1.7	0.8*1.7



Perfect Perf



PERF	16 TPI	12 TPI	8 TPI	6 TPI
Description	Item #	Item #	Item #	Item #
Card 10 ft (3 m)	T504	T506	T508	T510
Card 20 ft (6 m)	T505	T507	T509	T511
Paper 10 ft (3 m)	T604	T606	T608	T610
Paper 20 ft (6 m)	T605	T607	T609	T611

SNAP	4 TPI	3 TPI
Description	Item #	Item #
Card 10 ft (3 m)	T512	T514
Card 20 ft (6 m)	T513	T515
Paper 10 ft (3 m)	T612	T614
Paper 20 ft (6 m)	T613	T615

MICRO-PERF	30 TPI	40 TPI	50 TPI
Description	Item #	Item #	Item #
Paper 10 ft (3 m)	T619	T620	T621
Paper 20 ft (6 m)	T616	T617	T618

SLIT	
Description	Item #
Card 10 ft (3 m)	T502
Card 20 ft (6 m)	T503
Paper 10 ft (3 m)	T602
Paper 20 ft (6 m)	T603

SCORE	
Description	Item #
Card 10 ft (3 m)	T500
Card 20 ft (6 m)	T501
Card (round top) 20 ft (6 m)	T501-R
Paper 10 ft (3 m)	T600
Paper 20 ft (6 m)	T601

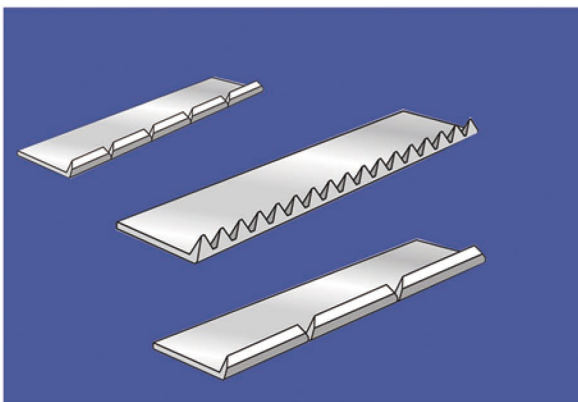

Printing Blanket

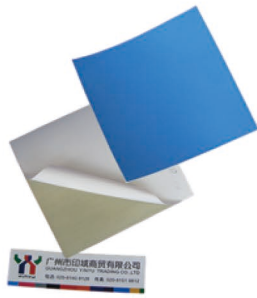

**Ceres Self-Adhesive
Printing Blanket**
Thickness: 0.95mm/ 1.95mm



**Ceres 362A Printing
UV Rubber Blanket**
Thickness: 1.95mm



**Conti-Air Series
Printing Rubber Blanket**
Thickness: 1.95mm

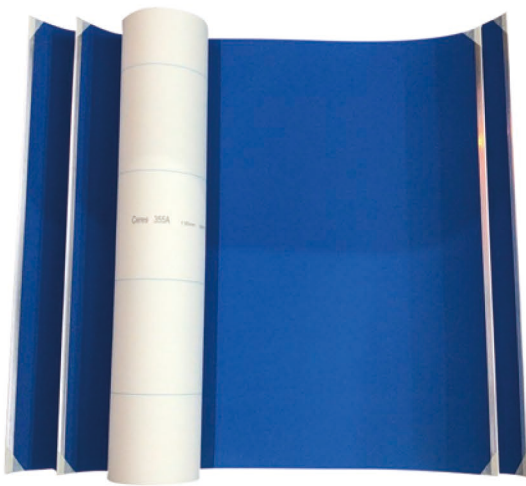

Ceres Blanket YY-355A

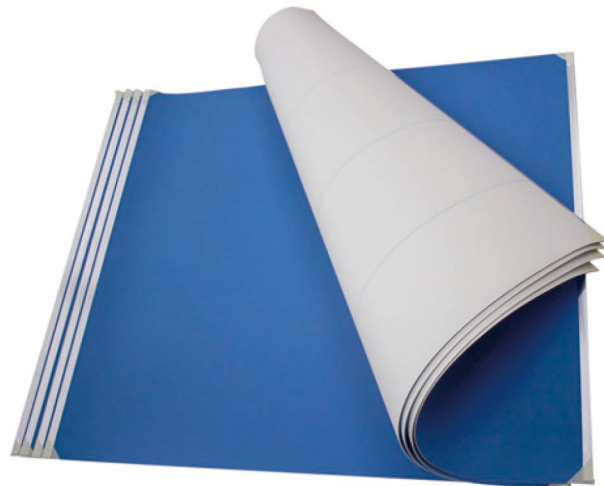

Ceres Blanket YY-386A



We could offer you all kinds of printing blankets, such as UV blanket, self-adhesive blanket, high-speed sheet-fed offset blanket, web printing blanket, bill printing blanket.
Thickness: 0.95mm, 1.68mm, 1.95mm.

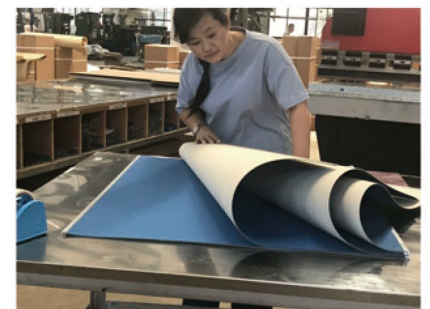

Blanket Factory



Printing Material



Ceres PS Plate

(Special specifications can be customized)



Ceres CTP Plate

(Special specifications can be customized)



ARFA HNU Film

Membrane: Outer/Inner
Diameter: 50.8mm-71.9mm
Flange: Hard/Soft

High contrast, red light, suitable for image recording of krypton laser sources.

The highest density is 5.0: the exposure and rinsing latitude is large, the resolution is high, and the dots and lines are clear and sharp.



ARFA HS Film



UGRA / Fujifilm Gray Scale



Image Remover/ KOYO Retouch Pen



Germany Viscovita Sponge

Printing Chemical



Printing Spare Part

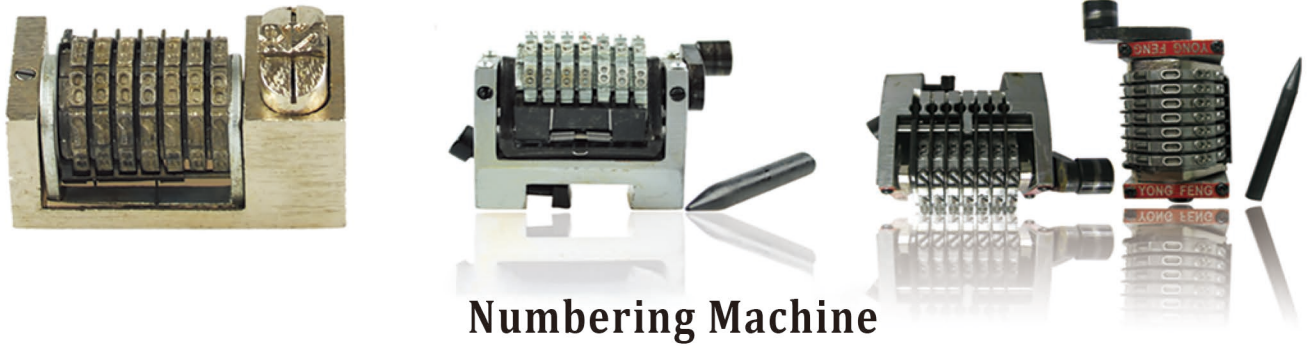
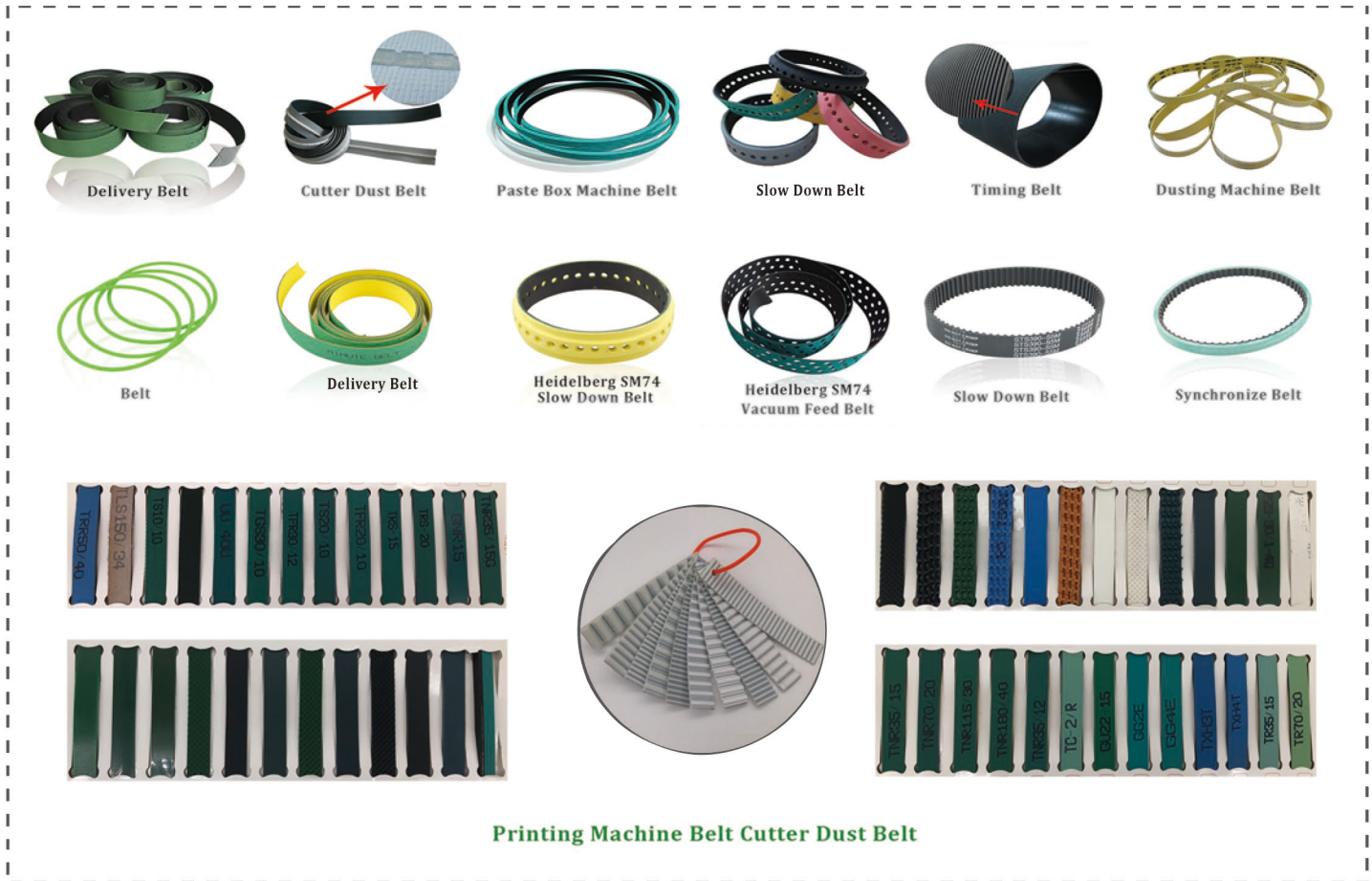

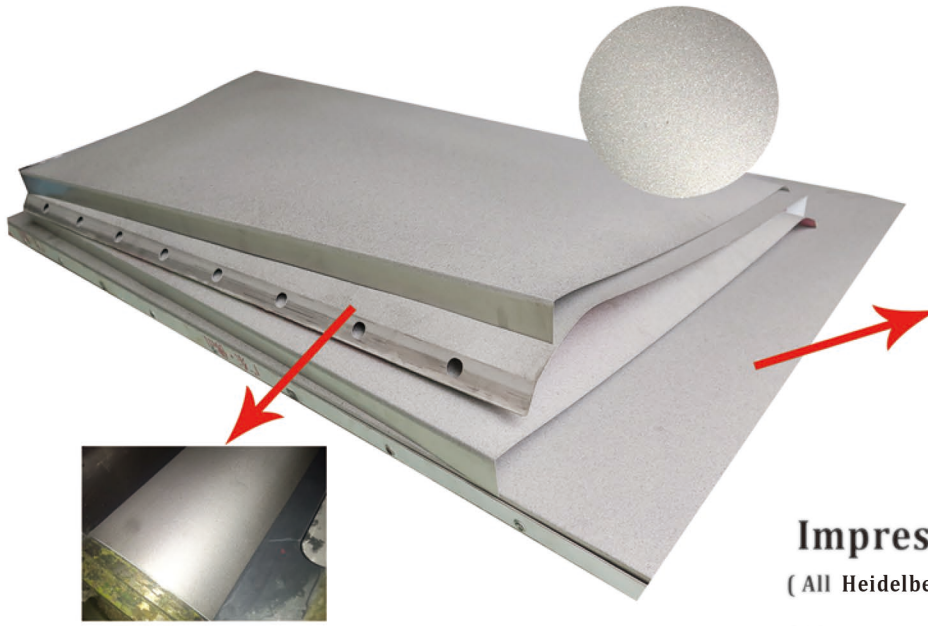

Impression Cylinder Jacket
(All Heidelberg, Komori, Roland, Mitsubishi, Ryobi, Akiyama etc could be customized)

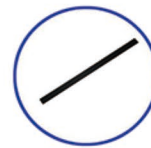
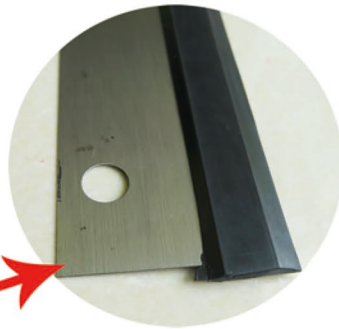
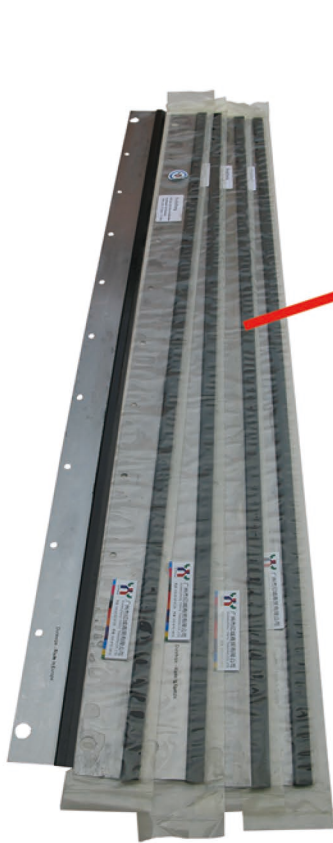

1、ink blade rubber
• High quality rubber , Durable and Acid resistance

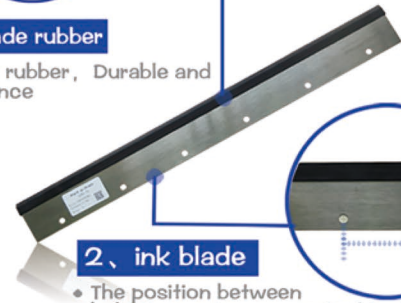

2、ink blade
• The position between holes is precise, convenient installation

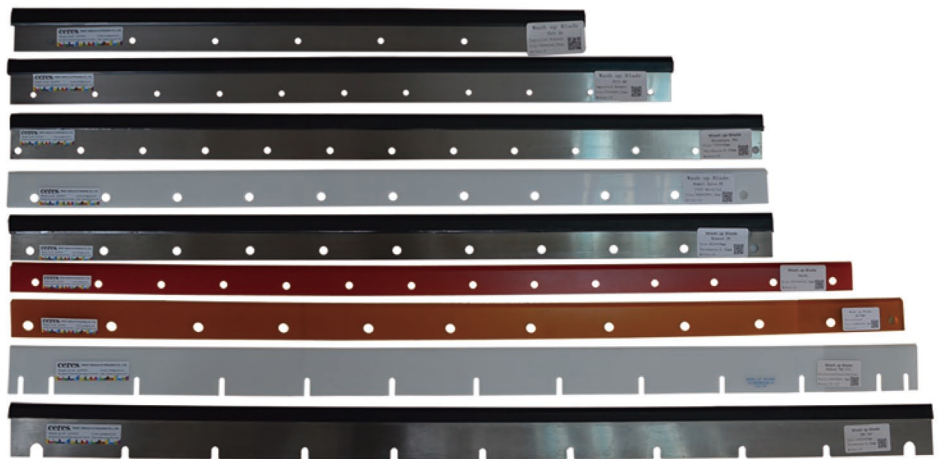

Wash Up Blades (All Heidelberg, Komori, Roland, Mitsubishi, Ryobi, Akiyama etc could be customized)

Printing Spare Part



Ceres001



Ceres002



Ceres003



Ceres004



Ceres005



Ceres006



Ceres007



Ceres008



Ceres009



Ceres010



Ceres011



Ceres012



Ceres013



Ceres014



Ceres015



Ceres016



Ceres017



Ceres018



Ceres019



Ceres020



Ceres021



Ceres022



Ceres023



Ceres024



Ceres025



Ceres026



Ceres027



Ceres028



Ceres029



Ceres030



Ceres031



Ceres032



Ceres033



Ceres034



Ceres035



Ceres036



Ceres037



Ceres038



Ceres039



Ceres040



Ceres041



Ceres042



Ceres043



Ceres044



Ceres045



Ceres046



Ceres047



Ceres048



NO. 300769



NO. 700047



NO. 300769



NO. 3001187



NO. 405807



NO. 500163

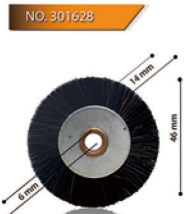

NO. 301628



NO. 300765



NO. 301422



NO. 405807



NO. 301188



NO. 300769

Brush Wheel

(All the sizes could be customized)

Printing Spare Part



Printing Spare Part

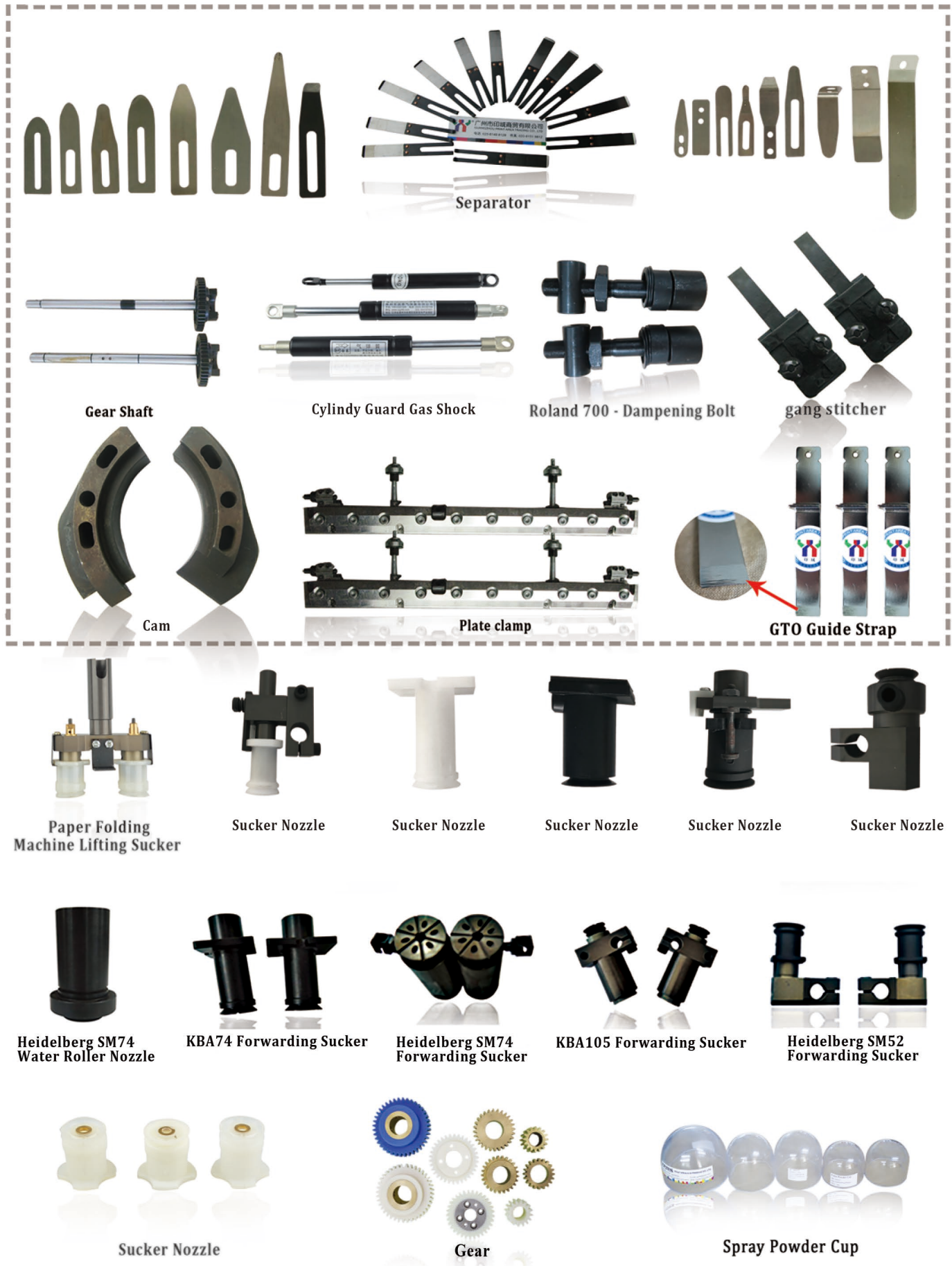

Printing Spare Part



Ink Roller (All Heidelberg , Komori, Roland, Mitsubishi, Ryobi, Akiyama etc could be customized)

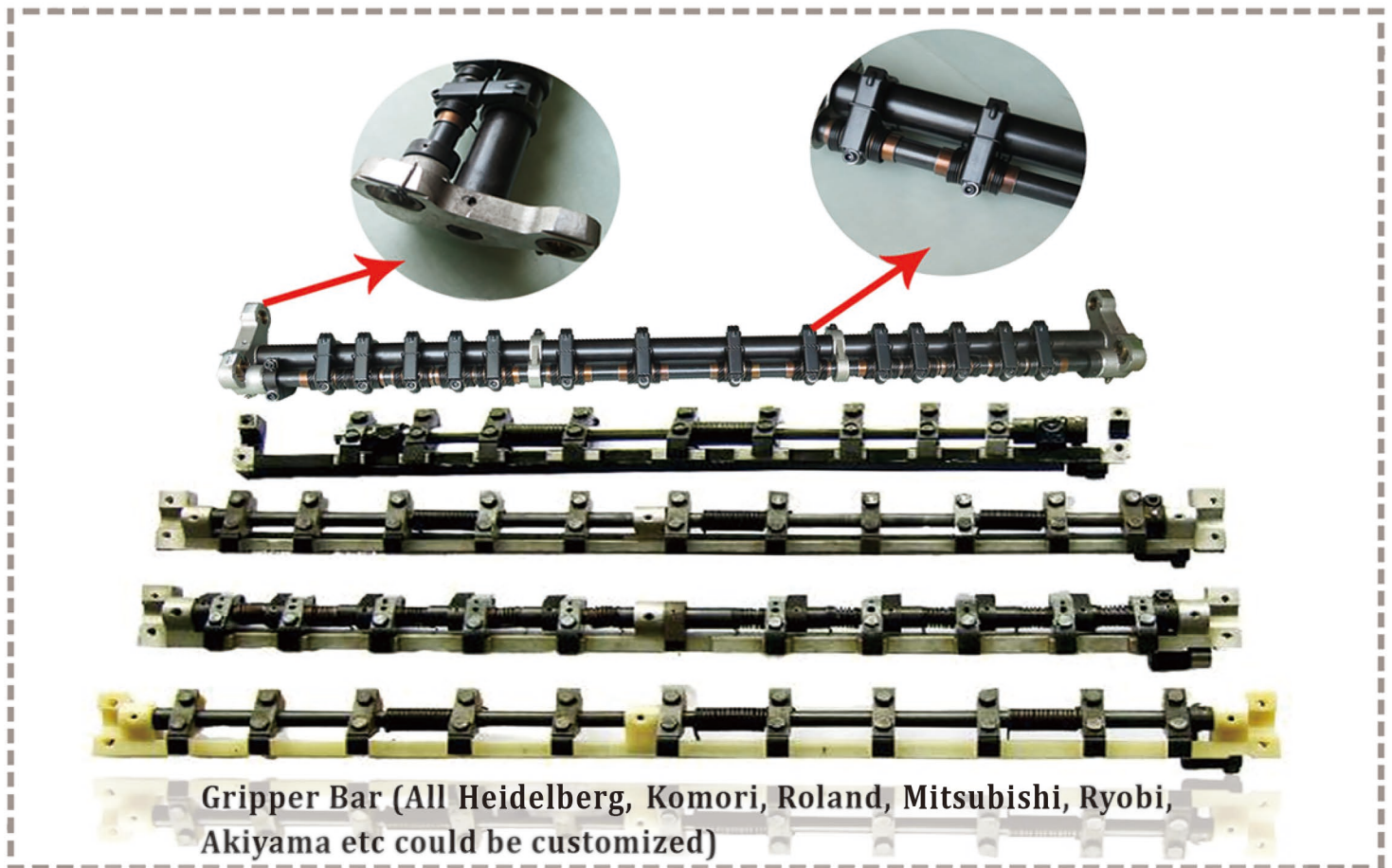

Gripper Bar (All Heidelberg, Komori, Roland, Mitsubishi, Ryobi, Akiyama etc could be customized)

Printing Spare Part

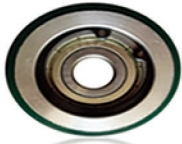

KBA72 Paper Wheel



Paper Wheel

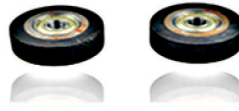

Paper Wheel



Belt Bonder



Heidelberg SM74 Fan



Fan



Heidelberg SM52 Cam Follower



Heidelberg Potentiometer



Kodak CTP Plate Making Machine Motor



Mitsubishi Ink Key Motor



Heidelberg Pressure Motor



Shinohara 52 Motor



Mitsubishi Spring



Kord Spring



Kord Spring



Torsional Spring



Roland 200 Gripper

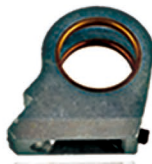

Komori Gripper Pad

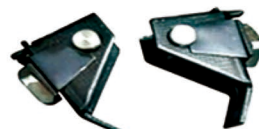

Komori 26 Delivery Gripper



Gripper



Mitsubishi Shaft



Fuji Paper Wheel Supporter



Kord Spare Part



Kord Spare Part



Heidelberg SM4 Festo Piston



Latch Needle



Heidelberg Bellow



Heidelberg SM102 Air Sac Plate Clamp

Printing Spare Part



YY01



YY02



YY03



YY04



YY05



YY06



YY07



YY08



YY09



YY10



YY11



YY12



YY13



YY14



YY15



YY16



YY17



YY18



YY19



YY20



YY21



YY22



YY23



YY24



YY25



YY26



YY27



YY28



YY29



YY30



YY31



YY32



YY33



YY34



YY35



YY36

Printing Rubber Sucker
(All the sizes could be customized)

Air Filter



Air Filter

(All sizes could be customized)

Double Wire - 0



PAPER PUNCHING MACHINE



DOUBLE WIRE BINDING MACHINE



YYHB-520A SEMI-AUTOMATIC
DOUBLE WIRE CLOSING MACHINE

DOUBLE WIRE - 0

Specification (inch)	Diameter (mm)	Tooth Pitch	Box-Packed (GW)	Roller Package (GW)	Teeth (LPS)
1/4	6.4	3:1	11.8KG (20box/pcs)	14.3KG	80000 LPS
5/16	7.9		15.5KG (20box/pcs)	14.4KG	58000 LPS
3/8	9.5		10.9KG (10box/pcs)	13.1KG	42000 LPS
7/16	11.1		23.2KG (20box/pcs)	12.6KG	28000 LPS
1/2	12.7		15.1KG (10box/pcs)	13KG	24000 LPS
9/16	14.3		18.3KG (10box/pcs)	12.3KG	18000 LPS
5/8	15.9		20.4KG (10box/pcs)	11.7KG	14000 LPS
5/8	15.9		18KG (20box/pcs)	11.2KG	10000 LPS
3/4	19.0	2:1	23.4KG (10box/pcs)	10KG	7000 LPS
7/8	22.0		14.6KG (10box/pcs)	8.8KG	4500 LPS
1	25.4		18.8KG (10box/pcs)	8.8KG	3600 LPS
MEASUREMENT:			52*42*52 (CM)		

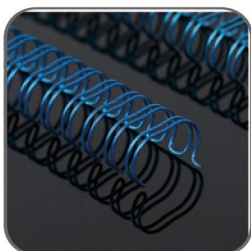



AUTO SEWING & FOLDING PAPER MACHINE

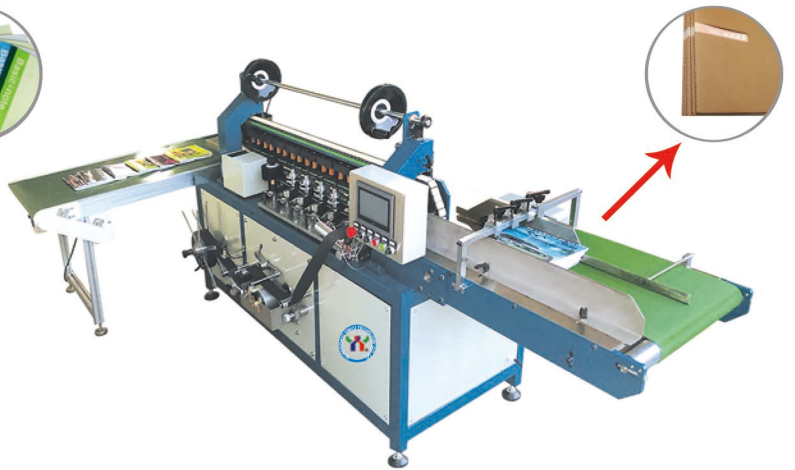

YYHB-620P PACK BACK MACHINE



ENVELOPE MAKING MACHINE



YYFM-1000 FILM LAMINA TING MACHINE



YYSG-1000/1200A UV COATING MACHINE



FOLDING BOX MACHINE



YYXQ-L210C LABEL PRINTING MACHINE



VERTICAL HYDRAULIC WASTE PAPER BALING MACHINE

The friendship lasts forever

